

- (1) **də** **pa** **[a]** **kēō** **hoŋ]** **[a]** **ḵāna]**
 3SINGULARHUMAN give ARTICLE woman DEFINITEHUMAN SINGULAR ARTICLE MilletPLURAL
 ' he gives some millet to the woman '
- (2) **kunu'um-a** **ka'i-a-r=** **uwaj-a** **w-ekyj**
 boy-REFERRER monkey-REFERRER-CASE= tail-REFERRER 3-pull
 ' the boy is pulling the monkey's tail '
- (3) **kumuha** **ang** **bata** **n-ang** **libro**
 get REFERRER child CASE-REFERRER book
 ' the boy got a book '
- (4) **mamu·k-ma** **qu·ʔas-ʔi**
 work-PRESENT man-DEFINITE
 ' the man works '
- (5) **qu·ʔas-ma** **mamu·k-ʔi**
 man-PRESENT work-DEFINITE
 ' the worker is a man '
- (6) **chōca** **in** **piltōntli**
 cry ARTICLE child
 ' the child cries '
- (7) **piltōnli** **in** **chōca**
 child ARTICLE cry
 ' the crying one is a child '
- (8) **temōquē** **chapōltin**
 FlyDown grasshopper
 ' grasshoppers flew down '
- (9) **newüthü** **aitahibi**
 jaguar BeDrunken
 ' the jaguar is drunken '
- (10) **pe-aitahibi-nü** **yawahiba**
 3-BeDrunken-MASCULINE dance
 ' the drunken one is dancing '
- (11) **tumakbo** **iyon**
 run ThisOne
 ' this one ran '
- (12) **bata** **iyon**
 child ThisOne
 ' this one is a child '
- (13) **nagnakaw** **ang** **tumakbo**
 steal REFERRER run
 ' the runner stole (something) '

- (14) **tumakbo** **ang** **bata**
 run REFERRER child
 ' the child ran '
- (15) **kʔweyʔ-∅** **cə** **nəŋənə**
 BeHungry-3ABSOLUTIVE DETERMINER MyChild
 ' the one that is my child is hungry '
- (16) **nəŋənə-∅** **cə** **k'wey'**
 MyChild-3ABSOLUTIVE DETERMINER BeHungry
 ' the one that is hungry is my child '
- (17) **xes-ɬc'eʔ** **x^we** **c'iʔ**
 good-meat DETERMINER deer
 ' deer is delicious '
- (18) **hiniraman** **n-ang** **babae** **n-ang** **pera** **ang** **bangko**
 BorrowPLACE CASE-REFERRER woman CASE-REFERRER money REFERRER bank
 ' the woman borrowed money from a bank '
- (19) **jetutyr-a** **morerekwat**
 MyUncle-REFERRER chief
 ' my uncle is a chief '
- (20) **jetutyr-a** **morerekwar-á**
 MyUncle-REFERRER chief-REFERRER
 ' my uncle is the chief '
- (21) **amerikano** **ang** **titser**
 American REFERRER teacher
 ' the teacher is an American '
- (22) **ang** **aleman** **ang** **doktor**
 REFERRER German REFERRER doctor
 ' the doctor is the German '
- (23) **mokōy** **rāka** **ã-ʔo** **ʔipirā**
 two PAST 1-eat fish
 ' I ate two fishes '
- (24) **kurdu-jarra-ngku** **ka-pala** **maliki** **wajili-pi-nyi** **wita-jarra-rlu**
 children-DUAL-ERGATIVE PRESENT-SUBJECTDUAL dog RunAfter-NONPAST small-DUAL-ERGATIVE
 ' two small children are running after the dog '
- (25) **kuati** **make** **koděšyš-atl**
 coati bite snake-TARGET
 ' the coati bit the snake '
- (26) **kuati** **make**
 coati mordre
 ' the coati bit '

- (27) **tsu-u-k atlat mapa**
 3-father-AGENT pan break
 ' his father broke the pan '
- (28) **atlat mapa**
 pan break
 ' the pan broke '
- (29) **Kumaru-k ha tichi**
 Kumaru-AGENT 1 scarify
 ' Kumaru scarified me '
- (30) **ha tichi**
 1 scarify
 ' someone scarified me / I scarified myself '
- (31) **fa-n kodetl-es**
 kill-3 animal-ACCUSATIVE/DATIVE
 ' he kills animals '
- (32) **hai-ts iyi husa-n**
 I-AGENT ? [sic] tie-3
 ' I already tied it '
- (33) **mut-pupe-n**
 cloth-TakeOff-3
 ' he takes off his clothes '
- (34) **hai-ts Kumaru sone ka wirix-es**
 I-AGENT Kumaru drink CAUSATIVE beer-TARGET
 ' I had Kumaru drink beer '
- (35) **hai-ts sone ka-n wirix-es**
 I-AGENT drink CAUSATIVE-3 beer-TARGET
 ' I had her drink beer '
- (36) **hai-ts chi_in Atawaka-k atlat mapa ka**
 I-AGENT FOCUS/TENSE Atawaka-AGENT pan break CAUSATIVE
 ' I had Atawaka break the pan '
- (37) **hai-ts chi_in inatle-k mapa ka-n**
 I-AGENT FOCUS/TENSE 3FEMENINE-AGENT break CAUSATIVE-3
 ' I had her break it '
- (38) [1 [2 [3 argument-agent + verb]₃ ± adjunct-affected]₂ + increment agent-causer]₁
- (39) [1 [2 [3 argument-patient + verb]₃ ± adjunct-cause]₂ + increment agent-causer]₁
- (40) **Yakairu sa**
 Yakairu dance
 ' Yakairu dances '

(41) **sa-n**
 dance-3
 'she dances'

(42) **hai-ts Yakairu sa ka**
 I-AGENT Yakairu dance CAUSATIVE
 'I had Yakairu dance'

(43) **hai-ts sa ka-n**
 I-AGENT dance CAUSATIVE-3
 'I had her dance'

(44) **newüthü₁ baitsi yala₂ Ø₂-xane-Ø₁**
 jaguar OVERTHEMATISATION porcupine 3ACCUSATIVE-eat-3NOMINATIVE
 'as for the jaguar, it eats the porcupine'

(45) **Kawiri₁ baitsi Ø₁-wereta-tsi₀**
 Kawiri OVERTHEMATISATION 3ACCUSATIVE-exterminate-4NOMINATIVE
 'as for the Kawiri, they were exterminated'

(46)

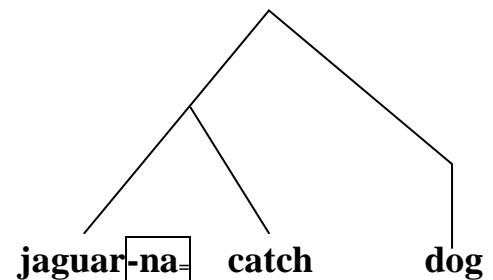
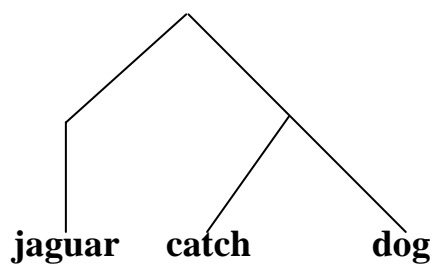

(47) **ĩpiarã Ø-ne-mẽ-rowa mĩ-Ø pitira ĩko kõ**
 MenERGATIVE REALISTRANSITIVE-3PLURALAGENT crocodile-ABSOLUTIVE two river LOCATIVE
 -3DUALPATIENT-KillPERFECTIVE
 'the men killed two crocodiles in the river'

(48) **kuərãhẽ mãmã re-kuə-ri**
 spindle FOCUS 3PLURALAGENT-make-PERFECTIVE
 'it's the spindles that make it'

(49) **[Pedro₁] [chamou [o João]] e Ø₁ foi embora**

(50) **[[dyo:ri₁-na=] man] [wa-hi= nuk]₂ dadohan Ø₂ niama**
 termite-MkCASE= make woman-PLURAL= group climb then
 'the termite warned the women and they climbed (in a tree)'

(51) **[John₁] [promised [Bill]] Ø₁ to feed himself₁**

(52) **[John] [persuaded [Bill₁]] Ø₁ to feed himself₁**

(53) **pai₁ mandou mãe₂ [[Ø₂]_{NP}] [ver [o cavalo₃]_{NP}]VP]**
 father Send3PAST mother seeNONFINITE DEFINITEMASCULINE horse
 'our father₁ sent our mother₂ to see₂ the horse₃'

- (54) **yabu-Ø** **ɲuma-ɲgu** **giga-n** [Ø] [[gubi-ɲgu] **mawa-li]**
 mother-ABSOLUTIVE father-ERGATIVE send-NONFUTURE doctor-ERGATIVE examine-PURPOSE
 ' father sent mother for she to be examined by the doctor '

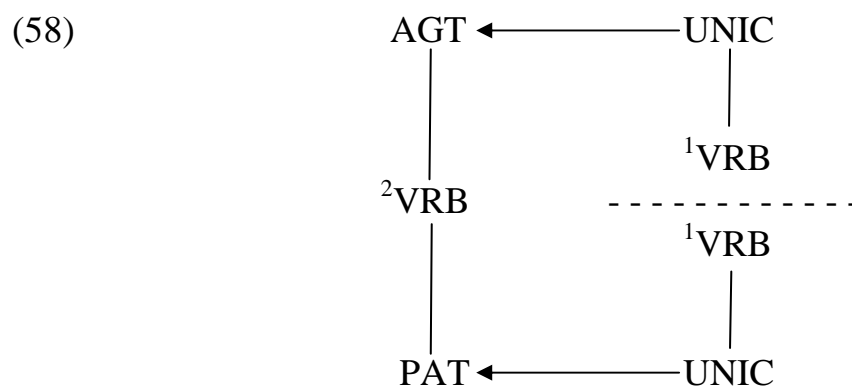
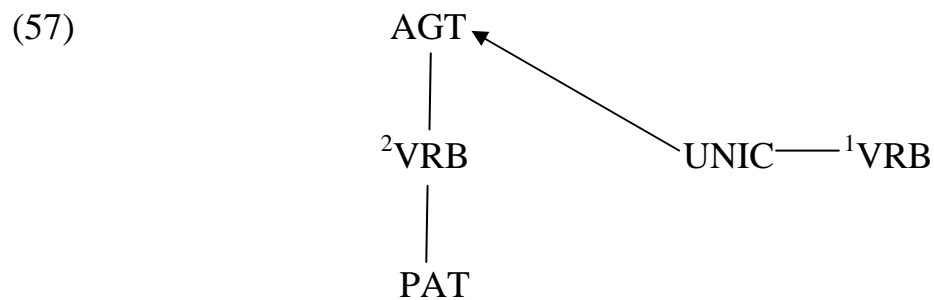
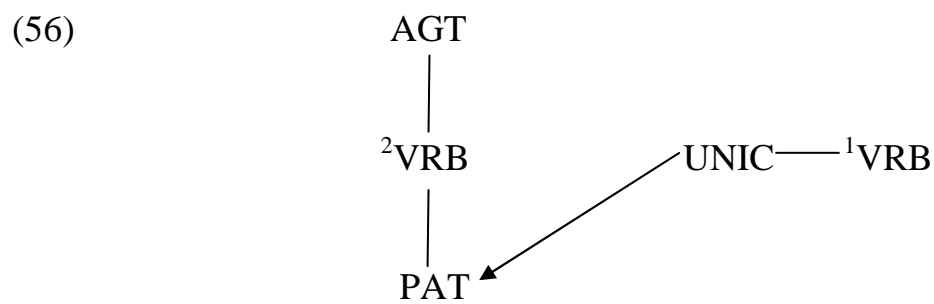
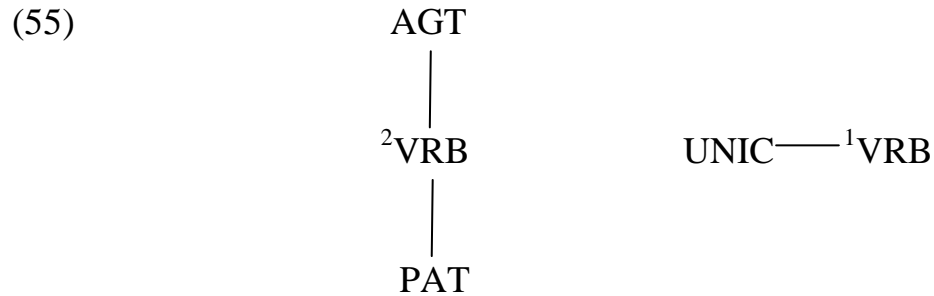

- (59) **mu·l** **má·taʔel-to** **wá··ʔw-an**
 DEMONSTRATIVE woman-NOMINATIVE walk-around-IMPERFECTIVE
 ' that woman walked around '

- (60) **Maʔi-n** **anʔvaki-∅** **riʃki-vai**
 Maʔi-ERGATIVE HerSon-ABSOLUTIVE spank-PASSADORECENTE
 'Maʔi spanked her son '
- (61) **pay-ta** **linwaras-ta** **yaçachi-ni**
 3-ACCUSATIVE Quechua-ACCUSATIVE teach-1
 'I tought Quechua to him '
- (62) **Kida-n** **Dunu-∅** **witsun-∅** **mene-bo-şh**
 Kida-ERGATIVE Dunu-ABSOLUTIVE wristband-ABSOLUTIVE give-RECENTPAST-3
 'Kida gave Dunu wristbands '
- (63) **[Tsoma-n** **joni-∅** **koriki-∅** **meni-a]-ra** **ono** **yaká-ke**
 tsoma-ERGATIVE man-ABSOLUTIVE money-ABSOLUTIVE give-COMPLETIVE distant sit-COMPLETIVE
 PARTICIPLE-EVIDENTIALITY
 '[the man [to whom Tsoma gave money]] is sitting further over there '
- (64) **[Tsoma-n** **joni-∅** **koriki-∅** **meni-a]-ra** **jawen** **pisha-n** **iki**
 tsoma-ERGATIVE man-ABSOLUTIVE money-ABSOLUTIVE give-
 COMPLETIVE his bag-LOCATIVE COPULA
 PARTICIPLE-
 EVIDENTIALITY
 '[the money [that Tsoma gave to the man]] is in his bag '
- (65) **ofiʔ-at** **sa-lhiyohli**
 dog-NOMINATIVE 1SINGULAR-RunAfter
 'the dog ran after me '
- (66) **ofiʔ-a** **sa-banna**
 dog-ACCUSATIVE 1SINGULAR-want
 'I want a dog '
- (67) **a-kuwa**
 1SINGULARNOMINATIVE-know
 'I know him '
- (68) **nah** **hiyap-ig**
 1AGENT see-3PATIENT
 'I see him '
- (69) **ne-hunata-me**
 1ACCUSATIVE-call-2NOMINATIVE
 'you call me '
- (70) **olvas-ok** **egy** **könyve-t**
 read-1SINGULARNOMINATIVE INDEFINITE book-ACCUSATIVE
 'I read a book '
- (71) **olvas-om** **a** **könyve-t**
 read-1SINGULARNOMINATIVE3DEFINITEACCUSATIVE DEFINITE book-ACCUSATIVE
 'I read the book '

- (72) **Pāsina hě ø-ti-ra-kye-sō-ri sōtimera ĩkyě mǎ**
 Pasina ERGATIVE REAL=3SINGULARERGATIVE=3SINGULAR ABOLUTIVE=1DATIVE=give-PERFECTIVE things 1 DATIVE
 'Pasina gave me things'
- (73) **les enfants chant-eront**
 DefinitePlural children sing-3PLURalfUTURE
 'the children will sing'
- (74) **nous chant-ons**
 1PLURAL sing-1PLURAL
 'we sing'
- (75) **Ino llam-ó**
 Ino call-3SINGULARPAST
 'Ino called'
- (76) **joy-chet is juyeni n-as lo:los**
 go-MIDDLE ARTICLEPLURAL person OBLIQUE-ARTICLENEUTER village
 'the people went to the village'
- (77) **kuyna:nak=i'ne**
 play-3FEMENINE
 'she's playing'
- (78) **ji:yi**
 cry
 'she cried'
- (79) **(Maria) na-purakü**
 Maria 3NOMINATIVE-work
 'Maria trabalhou'
- (80) **(michi) ũka-u na-ngõ?**
 cat rat-A CCUSATIVE 3NOMINATIVE-eat
 '(the cat) ate the rat'
- (81) **(michi) na-na-ngõ?**
 cat 3NOMINATIVE-3ACCUSATIVE-eat
 '(the cat) ate it'
- (82) **nah hiyap pewu**
 1AGENT see dog
 'I see the dog'
- (83) **jadya-tibu=dya-mikwana ba-na-wa**
 thus=CAUSE=FOCUS=2PLURAL see-ComeTemporarily-PERFECTIVE
 'this is why I have come to see you-all'

- (84) **tsunu-da-yatse** **iwa-kware**
 long-ADJECTIVESUFFIX=1DUAL WaitFor-REMOTE PAST
 ' we both waited for it a long time '

(85)

(25)

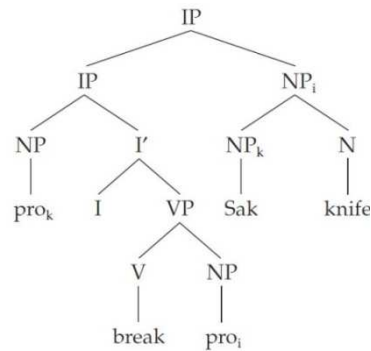

- (86) **homowabi₁** [**awiri₂** **Ø₂taika-Ø₁**]
 anaconda dog 3ACCUSATIVE-catch-3NOMINATIVE
 ' the anaconda caught the dog '

- (87) [**to** **hiaro** **boka**] **to** **khotaha**
 DETERMINER woman cook DETERMINER meat
 ' the woman cooks the meat '

- (88) [**tho-boka**] **khotaha**
 3FEMENINE-cook meat
 ' she cooks the meat '

- (89) **xãwãra-a** **a-xokã** **xe-ropy-a**
 onça-REFERRER 3AGENT-matar 1-pai-REFERRER
 ' my father killed the jaguar ~ the jaguar killed my father '

- | | | | |
|------|---|---|---|
| (90) | xe-ropy-a | a-xokã | xãwãra-a |
| | xãwãra-a | xe-ropy-a | a-xokã |
| | xe-ropy-a | xãwãra-a | a-xokã |
| | a-xokã | xãwãra-a | xe-ropy-a |
| | a-xokã | xe-ropy-a | xãwãra-a |

- (91) **wakial** **?o** **g** **wipsilo** **ha-cecposid**
 Cowboy AUXILIARY3 NEUTRALARTICLE calf 3PATIENTPLURAL-BrandPLURAL
 ' the cow-boy is branding the calves '

- | | | | | |
|------|--|-----------|--|--|
| (92) | wipsilo | ?o | ha-cecposid | g wakial |
| | ha-cecposid | ?o | g wakial | g wipsilo |
| | wipsilo | ?o | g wakial | ha-cecposid |
| | ha-cecposid | ?o | g wipsilo | g wakial |
| | wakial | ?o | ha-cecposid | g wipsilo |

- (93) **Aro-na=** **nuhuk** **a-obatyawa** **kariwa-na=** **ton**
 Aro-MKCASE= give 3SINGULAR-wife NonIndian-MKCASE=
 ' Aro gave his wife to the non-Indian '

- (94) **a-obatyawa kana Aro-na nuhuk kariwa-na= ton**
 3SINGULAR-wife FOCUS Aro-MkCase give NonIndian-MkCASE= LOCATIVE
 'it's his wife that Aro gave to the non-Indian '
- (95) **Juan i-ñake-ri maniti, opoñaka i-shiyaka**
 Juan 2AGENT-see-3PATIENT jaguar then 3AGENT-run
 'Juan₁ saw the jaguar₂ and ran_{1/2} away '
- (96) **aliasu-gami_{1(*2)} Piita_{1-Ø} piarar_{2-mik} kuni-juq**
 BeHappy-CAUSE4SINGULAR Peter-ABSOLUTIVE child-ACCUSATIVE kiss-MOOD3SINGULAR
 'Peter₁ kisses a child₂ because he_{1(*2)} is happy '
- (97) **Maʔi-n anʔvaki-Ø riʃki-vai**
 Maʔi-ERGATIVE son-ABSOLUTIVE spank-RECENTPAST
 'Maʔi spanked her son '
- (98) **ʔʃanu-Ø ʔni-ʔka-ai**
 ʔʃanu-ABSOLUTIVE hunt-go-IMMEDIATEPAST
 'Tshanu went hunting '
- (99) **wak allqu-Ø ayča-yki-ta miku-ya-n**
 that dog meat-2-ACCUSATIVE eat-DURATIVE-3
 'that dog is eating your meat '
- (100) **Moyan-manta Jwan-Ø shamu-sha-Ø**
 Moyan-ABLATIVE John come-PERFECTIVE-3
 'John came from Manta '
- (101) **mí·p-Ø mi·p-al šá·ka**
 3-NOMINATIVE 3ABSOLUTIVE killed
 'he killed him '
- (102) **mí·p-Ø káluhuya**
 3-NOMINATIVE WentHome
 'he went home '
- (103) **mi·p-al xá· ba·kú·ma**
 3-ABSOLUTIVE InWater fell
 'he fell into the water '
- (104) **haama-nm pee-ʔwiye wewukiye-na**
 man-AGENT 3SINGULARAGENT-KillPERFECTIVE deer-PATIENT
 'o homem matou o veado '
- (105) **haama-Ø hi-paanya**
 man-UNIC 3SINGULARÚNIC-ComePERFECTIVE
 'the man came '
- (106) **x-Ø-y-acañ najwinaj teʔñah**
 PERFECTIVE-3SINGULARABSOLUTIVE-3SINGULARERGATIVE-build TheMan TheHouse
 'the man built the house '

- (107) **x-Ø-topax** **najwinaj**
 PERFECTIVE-3SINGULARABSOLUTIVE-return TheMan
 ' the man went back '
- (108) **ne-hunata-me** **nawiata-me**
 1ACCUSATIVE-call-2NOMINATIVE return-2NOMINATIVE
 ' you called me ' ' you went back '
- (109) **wa-kté** **wa-ní**
 1SINGULARSUBJECTIVE-kill 1SINGULARSUBJECTIVE-live
 ' I kill him ' ' I live '
- (110) **ma-yá-kte** **ma-šiča**
 1SINGULAROBJECTIVE-2SINGULARSUBJECTIVE-kill 1SINGULAROBJECTIVE-BeBad
 ' you kill me ' ' I am bad '
- (111) **no-ñake-ri** **mani-ro** **mani-ti** **i-ñake-na**
 1AGENT-see-3PATIENT deerFEMENINE deerMASCULINE 3AGENT-see-1PATIENT
 ' I saw the deer ' ' the deer saw me '
- (112) **no-shiyaka** **shiyaka-na**
 1AGENT-RunGoOut RunGoOut-1PATIENT
 ' I went out / I ran ' ' I went out as a somnambulist / I ran away '
- (113) **[[pi:da-na=]NP duni]VP [wa:pa]NP**
 jaguar-MkCASE= catch dog
 ' the jaguar caught the dog '
- (114) **[yohan]VP [wa:pa]NP**
 bark dog
 ' the dog barked '
- (115) **[man-aye [=is-pa:ko]NP]VP [os rulrul]NP**
 meet-DIRECT ARTICLEPLURAL-dog ARTICLENEUTERPAST jaguar
 ' the dogs found a jaguar '
- (116) **[joy-chet]VP [is juyeni]NP n-as lo:los**
 go-MIDDLE ARTICLEPLURAL person OBLIQUE-ARTICLENEUTER village
 ' the people went to the village '
- (117) **ñipiarã Ø=ne-me=rowa mĩ pítira íko kō**
 MenERGATIVE REALISTRANSITIVE=3PLURALEGATIVE crocodileABSOLUTIVE two river LOCATIVE
 =3DUALABSOLUTIVE=KillPERFECTIVE
 ' the men killed two crocodiles in the river '
- (118) **yì-ria=pia kamerã kri tã**
 REALISINTRANSITIVE=2PLURAL=go YouAllABSOLUTIVE village ALLATIVE
 ' you-all went to the village '

- (119) **kuərāhē māmā re=kuə=ri**
 spindle FOCUS 3PLURALERGATIVE=make=PERFECTIVE
 ' it's the spindles that make it '
- (120) **ioṭi ikyi māmā pan iko yamā**
 anaconda long FOCUS move water INESSIVE
 ' it's the long anaconda that moves in the water '
- (121) **wa:pa tu kana mapiri-na= ti**
 dog negation focus anaconda-MkCase= kill
 ' it was not the dog that the anaconda killed '
- (122) **waro kana ki:tan**
 parrot focus sleep
 ' it's the parrot that slept '
- (123) **[John₁] [promised [Bill₂]] Ø₁ to feed himself₁**
- (124) **[John₁] [persuaded [Bill₂]] Ø₂ to feed himself₂**
- (125) **pai₁ mandou mǎe₂ [[Ø₂] [ver [o cavalo₃]]]**
 father Send3PAST mother see DEFINITEMASCULINE horse
 ' our father₁ sent our mother₂ to see₂ the horse₃ '
- (126) **yabu₁-Ø ḡuma₂-ḡgu giga-n [Ø₁] [[ḡubi₃-ḡgu] mawa-li]**
 mother-ABSOLUTIVE father-ERGATIVE send-NONFUTURE doctor-ERGATIVE check-PURPOSE
 ' father₂ sent mother₁ for the doctor₃ to check her₁ '
- (127) **o₁-na= hi:wan Wura₂ otatomahik-nin Ø₂**
 SomeoneElse-MkCase= call Wura die-DEPENDENCE
 ' someone else₁ called Wura₂ as he₂ died '
- (128) **paiko-hi= nuk₁-na= todiok-nin Ø₂ ma₁-hakhak-nin= wu Ø₂**
 Elder-PLURAL= group-MkCase= hate-DEPENDENCE 3PLURAL-StabREPEATEDLY-DEPENDENCE= want
 ' the elders₁ planned to stab₁ them₂ as they₁ hated them₂ '
- (129) **[yok-wu] barahai**
 ISINGULAR-want WildMeat
 ' I want wild meat '
- (130) **[yok-pu-nin= wu] barahai**
 ISINGULAR-eat want WildMeat
 ' I want to eat wild meat '
- (131) **kla t^heⁿgut^h**
 cow ILookAt
 ' I look at a cow '
- (132) **alku kǎp^y-a^s waʔt^yku**
 dog rabbit-DATIVE bite
 ' the dog bit the rabbit '

- (133) **~^ɔàb\ wédí tâh**
 jaguar eat tapir
 ' the jaguar eats tapirs '
- (134) **~^ɔàb\běh kÁjhí ~tõh-ŋ~dìh**
 dog bite pig-BENEFICIARY
 ' the dog bit the pig '
- (135) **~tõh kÁjhí ~^ɔàb\běh-ŋ~dìh**
 pig bite dog-BENEFICIARY
 ' the pig bit the dog '
- (136) **dàhá kÁhbõ hù?íp ~pêjh kôgⁿ dēh-ŋ~dìh**
 snake BiteKill FatherInLaw group-BENEFICIARY
 ' snakes killed all my fathers-in-law '
- (137) **oóhíbyé ihdó íñimyé-ke**
 dog bite snake-ACCUSATIVE
 ' the dog bites the snake '
- (138) **oóhíbyé ihdó úméhei**
 dog bite stick
 ' the dog bites the stick '
- (139) **mà-fn-ú**
 FUTURE-give-3SINGULAR→3SINGULAR
 ' she will give it to him '
- (140) **mà-fn-y-ú nendz-ò?**
 FUTURE-give-ANIMATE-3SINGULAR>3SINGULAR auxiliary-1SINGULAR
 ' she will give me to him '
- (141) **huni-ŋ bake inu bake**
 man-GENITIVE son jaguar son
 ' man's son ' ' jaguar's son '
- (142) **pok-nin bapo-nin kotsia-na= katu...**
 MakeSex-DEPENDENCE finish-DEPENDENCE otter-MkCASE= COMMITTATIVE
 ' having finished making sex with otters... '
- (143) **od^yoahi kodo oman kitok katu**
 hide up tree stick COMMITTATIVE
 ' he hid up in a tree with a stick '
- (144) **paxa₁ pe₁-sitopi₂ ø₂-tsutsune-ø₃**
 HerFather 3-TibiaMarrow 3ACCUSATIVE-SuckFACTUAL-3NOMINATIVE
 ' she sucked her father's tibia marrow '
- (145) **ne₁-sitopi₂-tsutsuni-ena-me₃**
 IACCUSATIVE-TibiaMarrow-SuckVIRTUAL-FUTURE-2NOMINATIVE
 ' suck my tibia marrow! '

- (146) **pe-ebarüto siohai-Ø**
 3-tongue rough-3NOMINATIVE
 'its tongue is rough '
- (147) **newüthü₁ pina ebarüto-siohai-Ø₁**
 jaguar HEARSAY tongue-rough-3NOMINATIVE
 'jaguar has a rough tongue, they say '
- (148) **ti:k yok-ki**
 BeBlack 1SINGULAR-head
 'I have lots of hair (lit.: my head is black) '
- (149) **ki-ti:k adu**
 head-BeBlack 1ABSOLUTIVE
 'I have lots of hair (lit.: I am black-headed) '
- (150) **Mayon-na= tuku Aro-na= bakon**
 Mayon-MKCASE= chop Aro-MKCASE= finger
 'Mayon chopped Aro's finger '
- (151) **nyama-na= pan-unyuk opatyin**
 mother-MKCASE= arm-scratch child
 'mother scratched the child's arm '
- (152) **nahetabihiriba-hü**
 RunAway-1NOMINATIVE
 'I ran away '
- (153) **Nusalia₁ nahetabihiriba-Ø₁**
 Nusalia RunAway-3NOMINATIVE
 'Nusalia ran away '
- (154) **Nusalia₁ ne₂-hunata-Ø₁**
 Nusalia 1ACCUSATIVE-call-3NOMINATIVE
 'Nusalia called me '
- (155) **Nusalia₁ Hialai₂ Ø₂-hunata-Ø₁**
 Nusalia Hialai 3ACCUSATIVE-call-3NOMINATIVE
 'Nusalia called Hialai '
- (156) **Hialai₁ Ø₁-hunata-tsi₀**
 Hialai 3ACCUSATIVE-call-4NOMINATIVE
 'Hialai was called '
- (157) **Hialai₁ Ø₁-hunata-tsi₀ Nusalia₂**
 Hialai 3ACCUSATIVE-call-4NOMINATIVE Nusalia
 'Hialai was called, by Nusalia '

- (158) **daan piya**
 go man
 ' the man went away '
- (159) **Mayon-na= tukman barahai**
 Mayon-MkCASE= cut WildMeat
 ' Mayon cut the wild meat '
- (160) **a₁-tukman barahai**
 3-cut WildMeat
 ' he₁ cut the wild meat '
- (161) **wa-wu dyara tukuna anya-na= katu**
 ANTIPASSIVE-want WhitePeople Indian woman-MkCASE= COMMITTATIVE
 ' Whites like Indian women '
- (162) **piya wa-pu-nin barahai**
 man ANTIPASSIVE-eat-DURATIVE WildMeat
 ' men are eating wild meat '
- (163) **wa-pu adik tyo**
 ANTIPASSIVE-eat 1ABSOLUTIVEPLURAL EXCLAMATIVE
 ' we ate! '
- (164) **a-obatyawa kana Aro-na nuhuk kariwa-na= ton**
 3SINGULAR-wife FOCUS Aro-MkCase give NonIndian-MkCASE= LOCATIVE
 ' it's his wife that Aro gave to the non-Indian '
- (165) **Aro kana wa-nuhuk a-batyawa kariwa-na= ton**
 Aro FOCUS ANTIPASSIVE-give 3SINGULAR-wife NonIndian-MkCASE= LOCATIVE
 ' it was Aro who gave his wife to the white man '
- (166) **wa-toman adu wiri katu wa**
 ANTIPASSIVE-shoot 1ABSOLUTIVE WildPig COMMITTATIVE FUTURE
 ' I'll shoot wild pigs '
- (167)
-
- wiri toman adu wa**
 WildPig shoot I FUTURE
 ' I'll shoot wild pigs '
- (168) **ni-pēh-ā-nān-ak**
 1-wait-DIRECT-TENSE-PLURAL
 ' we wait for him '

(169) **ni-pēh-iko-nān-ak**

1-wait-INVERSE-TENSE-PLURAL
' he waits for us '

(170) **a-kuwa**

1SINGULARNOMINATIVE-know
' I know him '

e-kuwa

1SINGULARACCUSATIVE-know
' he knows me '

(171) **ofi?-at**

dog-NOMINATIVE

sa-lhiyohli

1SINGULAR-RunAfter

' the dog ran me '

(172) **ofi?-a**

dog-ACCUSATIVE

sa-banna

1SINGULAR-want

' I want a dog '

(173) **kon-na=?ne**

TakeOff-DIRECT=3FEMENINE

is

ARTICLE

empana:da

MeatCake

' she takes off the meat cake '

(174) **ew-kaya=?ne**

hold-INVERSE=3FEMENINE

os

ARTICLE

alamre

wire

' a wire held her back '

(175) **tikoy-na=us**

kill-DIRECT=3MASCULINEABSENTIAL

os

ARTICLENEUTERPAST

mimi:di

snake

' he killed the snake '

(176) **tikoy-kaya=us**

kill-DIRECT=3MASCULINEABSENTIAL

os

ARTICLENEUTERPAST

mimi:di

snake

' the snake killed him '

(177) [**the snake**] is [[**his**] **killed**]

(178) [**the snake**] is [[**his**] **killer**]